

**telecom**  
unitronics

**Cablematic**  
CABLE PREPARATION TOOLS

**CABLE  
PREPARATION  
TOOLS  
FOR CATV AND  
TELECOMMUNICATIONS**



# Table of Contents

## TRUNK AND DISTRIBUTION TOOLS

QCST QUICK CHANGE Coring/Stripping Tool	C7-C8
JST Jacket Stripping Tool	C9
AJST Armored Jacket Stripping Tool	C10
CST Coring & Stripping Tools	C11-C12
ACST Adjustable Coring & Stripping Tool	C11, C13
QRT Tool Kit for CommScope® Quantum Reach® (QR) Cable	C14
JCST-QR Jacket Coring Stripping Tool	C15
MWSS Messengered Web Slitter/Shaver	C16
MWS Messengered Web Slitter	C16
CST-MC Trilogy Coring & Stripping Tool	C17
CST PB10 Coring & Stripping Tool for Trilogy PerfectBonded 10™ (PB10) Coaxial Cable	C18
CC-100 Center Conductor Cleaner	C19
CC-200 Center Conductor Scraper	C19
CXC, CXC-1 Cable Cutters	C20
"CC" Series Cable Cutters/Stripper	C20
SLT Stripping Tools for European Coaxial Cable	C21

## DROP TOOLS

TXFF, TXFF-Q Flexible Feeder Stripping Tools	C22
SDT-TXFF Flexible Feeder Single Drop Trimmer	C22
CST 320/7C QRF Coring & Stripping Tool for "F" Type Connectorization	C23
UT Drop Cable Trimmer	C23
<b>NEW</b> DDT Dual Drop Trimmer	C24
<b>NEW</b> LDT Lightweight Drop Trimmer	C25
UDT Universal Drop Trimmer	C26-C27
SDT Single Drop Trimmer	C28-C29
DCS Drop Cable Slitter	C30
CR Hex Crimp Tool	C30-C31
CR-AL Aluminum SuperLite Crimp Tools	C32
CR-Ratchet Full Cycle Crimp Tool	C32
CAT Compression Assembly Tool	C33
<b>NEW</b> LWC, LWC-1 Lightweight Compression Assembly Tool	C34
<b>NEW</b> CAT-AS "All Series" Compression Assembly Tool	C35
<b>NEW</b> CAT-MULTIMEDIA Multimedia Compression Assembly Tool	C36
CAT-AIO Compression Assembly Tool	C37-C39
RTT Round Taper Tool	C40
TW Torque Wrenches	C40
TW-AH-B, TW-AH-S, TW-AH-516, TW-AH, TW-AH/IT Torque Wrenches	C41
S-200 Security Shield Tool	C42
<b>NEW</b> IT-F59, 6, 11 "F" Connector Insertion Tool	C42
TT 716 Trap Tool	C43
TST 716 Trap Security Tool Combo	C43
T-7916 Tap Tool	C43
<b>NEW</b> CW-1 Multi-Socket Can Wrench	C44
<b>NEW</b> CW71638 Can Wrench	C44
<b>NEW</b> TT8 Tap Tool - Extra Long	C45
<b>NEW</b> TT8-TW40 Tap Tool with attached Swivel Torque Wrench	C45
DK 1 Drop Cable Preparation Kit	C46
RPT Premise Toner Drop Cable Continuity Tester	C46
LTT-4, LTT-7 Locking Terminator Tools	C46
<b>NEW</b> LTT-7/V23, LTT-7/T-P, LTT/NS6270 Locking Terminator Tools	C47

## SPECIALTY TOOLS

RT-F716 Removal Tool	C48
RT-BNC Removal Tool	C48
THT-532 5/32" Telephone Hex Tool	C48
CTB Canvas Tool Bag	C49
CT 375 Carpet Cutter & Drill Guide	C49
CCD-1, CCD-1H, CCD-CL, CCD-CLW Cable Caddies	C50
DC-MSES Mid-Span Duct Cutter	C51
DC 100 Cable Duct Cutters	C51

## WIRELESS TOOLS

MSES-50 Mid-Span/End Stripper	C52
FT-12-50, FT-78-50, FT-114-50, FT-158-50 Flaring Tools	C53
HSK Antenna Hole Saw Kits	C53

Our products are covered by the following patents: 3,659,483; 3,820,420; 270,992; 5,305,529; 5,713,132; 5,392,508; 5,596,800; 5,743,131; 5,934,137; 4,955,137; 6,131,289; 6,128,976; 6,112,404; D431,441; 6,253,641; 5,713,132; 6,427,331; 6,467,171; 6,581,291

# QCST

## QUICK CHANGE Coring/Stripping Tool

- **ALL-IN-ONE**, accurately strips the jacket, cores out the dielectric, strips and bevels the aluminum sheath
- **NEW DESIGN** conveniently attaches the jacket stripper body (QJST) to the main body of the coring and stripping tool by means of a "QUICK-CHANGE" rotating body ring
- QJST color coded **JACKET STRIPPING BODY** is removed and used in a 2 STEP OPERATION WHEN USING FLOODED CABLES. STEP 1 - Remove the jacket with the removable QJST. STEP 2 - Remove flooding compound from cable and use the QCST coring and stripping tool body to complete the preparation
- Jacket stripping body (QJST), when used separately to remove the jacket on flooded cable, is uniquely designed to automatically provide 3.50 inch (88.9 mm) of jacket removal when rotated to the end of the body
- Jacket stripper body and coring / stripping tool guide sleeve are all COLOR CODED for easy cable identification
- **CHAMFERED STRIP STOP** is factory installed. A 1" (25.4 mm) stop for 412-750 tools and a 1-1/16" (27 mm) stop for 840-1160 tools
- Pre-set jacket blade assures no scoring or nicking of aluminum sheath
- **MANUAL** or **DRILL** operation; QCST tools have a standard "T" handle with a built-in 3/8 inch (9.5 mm) drill adapter; QCST-R tools have a **RATCHET** "T" handle and a separate 3/8 inch (9.5 mm) drill adapter
- Rugged, durable, ALL-METAL construction
- Heat treated sheath cutting blade produces a smooth beveled edge and can be replaced without the expense of replacing the entire coring bit
- Spiral-fluted, heat treated steel bit
- Use of CC-100 or CC-200 Center Conductor Cleaner/Scrapper removes residual dielectric which remains on the conductor after coring and stripping
- U.S. Patent No.: D431,441
- Made in the U.S.A.
- Length: 8.1 in (205.7 mm)
- Weight: 1 lb 4 oz (525 g)

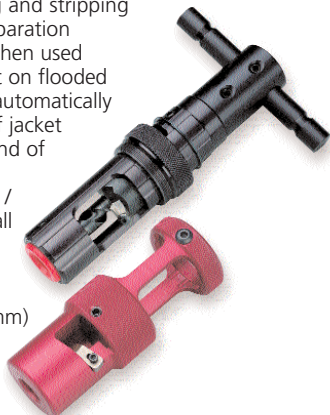

## Ordering Guide for QCST Tools (Quick-Change – All-in-One)

CommScope® P3 Cable; TIMES FIBER T10 Cable

Cable	Standard Tool	Ratchet Tool	Coring Bit Kit	Guide Sleeve	Chamfered Strip Stop	Body Color
412	QCST 412 T	QCST 412T-R	CB 114K	29104	34942	Black
500	QCST 500 T	QCST 500T-R	CB 115K	29105	34942	Red
625	QCST 625 T	QCST 625T-R	CB 116K	29106	34942	Blue
750	QCST 750 T	QCST 750T-R	CB 117K	29111	34943	Green
875	QCST 875 T	QCST 875T-R	CB 118K	29112	34927	Yellow
1000	QCST 21000 T	QCST 21000T-R	CB 119K	29113	34927	Orange

TIMES FIBER TX and CommScope® P3 Cable

Cable	Standard Tool	Ratchet Tool	Coring Bit Kit	Guide Sleeve	Chamfered Strip Stop	Body Color
565	QCST 565	QCST 565-R	CB 146K	29108	34942	Red
700	QCST 700	QCST 700-R	CB 137K	33847	34943	Blue
840	QCST 840	QCST 840-R	CB 138K	29109	34927	Green
1160	QCST 21160	QCST 21160-R	CB 158K	33837	34927	Neutral

## Accessories for QCST Tools (Quick-Change – All-in-One)

Cable	Ratchet Handle	Drill Adapter	Sheath Cutting Blade	Jacket Stripping Blade
412 to 840	31250	31230	CB 60	CB 6667H
860 to 1000	31275	31235	CB 60	CB 6667H
1160	31275	31235	CB 26	CB 6667H

# JST

## Jacket Stripping Tools

- Fast and efficient removal of jackets from trunk and distribution coaxial cables
- New anodized color-coded bodies to match our coring and stripping tool sleeves (standard JST 412 through JST 1160 only)
- Preset JST blades minimize scoring or nicking of the aluminum sheath
- Knurled body for sure grip
- Replacement blade for all JST tools is CB 6667H
- U.S. Patent No.: 3,659,483
- Length: 2.63 in. (67 mm)
- Weight: 6.0 oz. (170 g)



**JST 500**



**JST 625**



**JST 750**



**JST 875**

### CommScope® P3 Cable TIMES FIBER T4 Plus, T6, T10

Cable	Model Number	Color
412	JST 412	Black
500	JST 500	Red
625	JST 625	Blue
750	JST 750	Green
875	JST 875	Yellow
1000	JST 1000	Orange

### TIMES FIBER TX Cable CommScope® P3 Cable

Cable	Model Number	Color
565	JST 565	Red
700	JST 700	Black
840	JST 840	Green
1160	JST 1160	Neutral

### TRILOGY MC® Cable

Cable	Model Number
440	JST 440MC
500	JST 500MC
650	JST 650MC
750	JST 750MC
1000	JST 1000MC

## Special Jacket Strippers

### CommScope® P1, P2 Cable TIMES FIBER T4 Cable Alcatel Cable Benelux – ACE Cable

Cable	Model Number
412	JST 412X
500	JST 500X
625	JST 625X
750	JST 750X
875	JST 875X
1000	JST 1000X

### TIMES FIBER T10 Extra Thick Jacket CommScope® P3 Extra Thick Jacket

Cable	Model Number
412	JST 412 TFCJBX
500	JST 500 TFCJBX
565	JST 565 TXJBX
625	JST 625 TFCJBX
700	JST 700 TXJBX
750	JST 750 TFCJBX
840	JST 840 TXJBX
875	JST 875 TFCJBX
1000	JST 1000 TFCJBX
1160	JST 1160 TXJBX

### CommScope® Cable Guard Cable

Cable	Model Number
500	JST 500CG
625	JST 625CG
750	JST 750CG
875	JST 875CG

### CommScope® QR Dual Jacket Cable

Cable	Model Number
540	JST 540 DJ
715	JST 715 DJ
860	JST 860 DJ

### TIMES FIBER T10/BF CommScope® P3/JCASP Flooded Cable

Cable	Model Number
500	JST 10-60040
625	JST 10-72540
750	JST 11-85040

### GENERAL CABLE Fused Disc Cable

Cable	Model Number
412	JST 412A
500	JST 500A
750	JST 750A

# AJST

## Armored Jacket Stripping Tool



- AJST is designed to remove the outer jacket and armor layer on CommScope P3 JACASS and QR JACASS underground construction trunk and distribution cable
- Factory preset blade with no adjustment required
- Unique design has a common handle and interchangeable stripping heads for a range of cable sizes
- Rugged, color coded anodized aluminum design (same as other Cablematic® tools) for easy identification and long life
- Extra long handle provides better stripping leverage and greater hand protection from armor chips (always wear hand and eye protection)
- Replacement Blade: CB 213
- Length: 6.25" (159 mm)
- Weight: 11 oz (312 g)

### CommScope® P3 Cable

Cable	Model Number	Color
412	AJST 412/P3	Black
500	AJST 500/P3	Red
625	AJST 625/P3	Blue
750	AJST 750/P3	Green
875	AJST 875/P3	Orange

### CommScope® QR® Cable

Cable	Model Number	Color
540	AJST 540QR	Copper
715	AJST 715QR	Copper
860	AJST 860QR	Copper

## CST

### Coring & Stripping Tools



- Combination tool cores and strips in one fast and precise operation
- Manual or drill operation; CST tools have a standard "T" handle with a built-in 3/8 inch (9.5mm) drill adapter; CST-R tools have a ratchet "T" handle and a separate 3/8 inch (9.5 mm) drill adapter
- Heat treated sheath cutting blade produces a smooth beveled edge and can be replaced without the expense of replacing the entire coring bit
- Spiral-fluted, heat-treated steel coring bit
- Rugged, durable, all-metal construction
- Strip stops available for exact stripping lengths of 0.50 to 2.00 inch (12.7 to 50.8 mm)
- Color coded cable guide sleeves for easy cable size identification
- Use of CC-100 or CC-200 Center Conductor Cleaner/Scrapper removes residual dielectric which remains on the conductor after coring and stripping
- Length: 6.88 in (175 mm)
- Weight: 13 oz (369 g)

## ACST

### Adjustable Coring & Stripping Tools



- **ACST offers an adjustable chamfering strip stop**
  - Strip stop length changed by simple adjustment of external screw in tool body
  - Center conductor length can be adjusted from 1/2" (12.7 mm) to 2" (50.8 mm)
  - Integral strip stop chamfers the center conductor, negating the need for a separate chamfering tool
- ACST retains all the same quality features of the standard CST tool (heat treated coring bits, replaceable sheath cutting blades)
- Available in T-handle or ratchet, and all are drill adaptable
- New drill adapter allows use of common "quick disconnect" drill chucks
- Length: 8.88 in (225.5 mm) maximum
- Weight: 16 oz (454 g)

## Ordering Guide for CST Tools

CommScope® P1, P3 Cable Guard Cable; TIMES FIBER T4, T6, T10 Cable; Alcatel Cable Benelux – ACE Cable

Cable	Standard Tool	Ratchet Tool	Coring Bit Kit	Guide Sleeve	Sleeve Color
412	CST 412	CST 412-R	CB 114K	29104	Black
500	CST 500	CST 500-R	CB 115K	29105	Red
625	CST 625	CST 625-R	CB 116K	29106	Blue
750	CST 750	CST 750-R	CB 117K	29111	Green
875	CST 875	CST 875-R	CB 118K	29112	Yellow
1000	CST 21000	CST 21000-R	CB 119K	29113	Orange

### TIMES FIBER TX and CommScope® P3 Cable

Cable	Standard Tool	Ratchet Tool	Coring Bit Kit	Guide Sleeve	Sleeve Color
565	CST 565TX	CST 565TX-R	CB 146K	29108	Red
700	CST 700TX	CST 700TX-R	CB 137K	33847	Black
840	CST 840TX	CST 840TX-R	CB 138K	29109	Green
1160	CST 21160TX	CST 21160TX-R	CB 158K	33837	Neutral

### CommScope® PowerFeeder™ and TIMES FIBER T10 Power 20, 22 & 50 Ohm Cable

Cable	Standard Tool	Ratchet Tool	Coring Bit Kit	Guide Sleeve	Sleeve Color
625/PF	CST 625PF*	CST 625PF-R	CB 201K	29106	Blue
625/20	CST 625/20	CST 625/20-R	CB 203K	29106	Blue
625/50	CST 625/50	CST 625/50-R	CB 200K	29404	Blue

\* Tool model CST 625PF for CommScope® PowerFeeder and TIMES FIBER T10 Power 22 Ohm Cables

## Accessories for CST Tools

Cable	Ratchet Handle	Drill Adapter	Sheath Cutting Blade
412 to 840	31250	31230	CB 60
860 to 1000	31275	31235	CB 60
1160	31275	31235	CB 26

## Conductor Strip Stops for CST Tools

Strip Length		Part Number	Strip Length		Part Number
(inch)	(mm)		(inch)	(mm)	
1/2	12.70	32974	1-1/4	31.75	32983
5/8	15.88	32975	1-3/8	34.93	32981
3/4	19.05	32985	1-7/16	36.51	33957
13/16	20.64	33958	1-1/2	38.10	32982
7/8	22.22	32977	1-9/16	39.69	33959
15/16	23.81	32978	1-11/16	42.86	32984
1	25.40	32980	1-3/4	44.45	33967
1-1/16	26.99	32979	2	50.80	33962
1-1/8	28.58	33973			
1-3/16	30.16	32986			

## Ordering Guide for Adjustable CST Tools

### CommScope® P3 Cable, TIMES FIBER, T10 Cable

Cable	Standard Tool	Ratchet Tool	Coring Bit Kit	Guide Sleeve	Sleeve Color
412	ACST 412	ACST 412-R	CB 114K	29104	Black
500	ACST 500	ACST 500-R	CB 115K	29105	Red
625	ACST 625	ACST 625-R	CB 116K	29106	Blue
750	ACST 750	ACST 750-R	CB 117K	29111	Green
875	ACST 875	ACST 875-R	CB 118K	29112	Yellow
1000	ACST 1000	ACST 1000-R	CB 119K	29113	Orange

### CommScope® P3 Cable and TIMES FIBER TX

Cable	Standard Tool	Ratchet Tool	Coring Bit Kit	Guide Sleeve	Sleeve Color
565	ACST 565TX	ACST 565TX-R	CB 146K	29108	Red
700	ACST 700TX	ACST 700TX-R	CB 137K	33847	Black
840	ACST 840TX	ACST 840TX-R	CB 138K	29109	Green
1160	ACST 1160TX	ACST 1160TX-R	CB 158K	33837	Neutral

### CST MC — Trilogy Coring and Stripping

Cable	Standard Tool	Ratchet Tool	Coring Bit Kit	Guide Sleeve
440	ACST 440MC	ACST 440MC-R	CB 131K	33771-1
500	ACST 500MC	ACST 500MC-R	CB 132K	33771-2
650	ACST 650MC	ACST 650MC-R	CB 133K	33771-3
750	ACST 750MC	ACST 750MC-R	CB 134K	33771-4
1000	ACST 1000MC	ACST 1000MC-R	CB 157K	33777

## Accessories for Adjustable CST Tools

Cable	Ratchet Handle	Drill Adapter	Sheath Cutting Blade
412 to 840	31250	31230	CB 60
860 to 1000	31275	31235	CB 60
1160	31275	31235	CB 26

# QRT

## Tool Kits for CommScope® Quantum Reach® (QR) Cable



- Specifically designed for CommScope® Quantum Reach® (QR) cables and also prepares Alcatel Cable Benelux – ACW cable
- QRT Kits include a coring and stripping tool and a jacket stripping tool (CSTQR & JSTQR)
- **JSTQR now conveniently snaps onto the CSTQR for ease of storage**
- JSTQR available separately for replacement
- QR Kits now in bronze anodized color for easy QR identification
- Manual or drill operation; CST tools have a standard "T" handle with a built-in 3/8 inch (9.5 mm) drill adapter; CST-R tools have a ratchet "T" handle and a separate 3/8 inch (9.5 mm) drill adapter
- Heat treated, sheath cutting blade produces a smooth beveled edge and can be replaced without the expense of replacing the entire coring bit
- Use of CC-100 or CC-200 Center Conductor Cleaner/Scraper removes residual dielectric which remains on the conductor after coring and stripping
- CSTQR Length: 8.38 in (213 mm) • Weight: 1 lb (454 g)
- JSTQR Length: 2.63 in (67 mm) • Weight: 6 oz (170 g)

## QRT ORDERING GUIDE

Cable	Model Number Standard Handle*	Coring Bit Kit	Guide Sleeve	JSTQR Blade
320 (7 mm)	QRT 320	CB 164K	35144	CB 6667H
500	QRT 500	CB 130K	33404	CB 6667H
540	QRT 540	CB 143K	33787	CB 6667H
715	QRT 715	CB 159K	34663	CB 6667H
860	QRT 860	CB 127K	33371	CB 6667H
1125	QRT 1125	CB 145K	–	CB 6667H

\* Ratchet tool models are the same, with a "-R" suffix.

# JCST-QR

## Jacket Coring Stripping Tool



- Simultaneously strips the jacket, cores the dielectric, strips the aluminum sheath and trims the conductor to the proper length in one fast and precise operation on CommScope® Quantum Reach® Cable
- Specifically designed for CommScope® QR cables, also prepares Alcatel Cable Benelux – ACW cable
- Manual or drill operation; JCST tools have a standard "T" handle with a built-in 3/8 inch (9.5 mm) drill adapter; JCST-R tools have a ratchet "T" handle and a separate 3/8 inch (9.5 mm) drill adapter
- Heat treated, sheath cutting blade produces a smooth beveled edge and can be changed without the expense of replacing the entire coring bit
- Preset jacket blade assures there is no scoring or nicking of the aluminum sheath
- Rugged, durable all-metal construction
- **Not recommended for use on flooded cable (see QRT model)**
- Jacket Blade: CB 6667H
- Sheath Cutting Blade: CB 60
- Made in the U.S.A.
- Length: 7.50 in (190.5 mm)
- Weight: 1 lbs 8 oz (675 g)

## JCST-QR ORDERING GUIDE

Cable	Model Number Standard Handle	Model Number Ratchet Handle	Coring Bit Kit
320/7 mm	JCST 7MMQR	JCST 7MMQR-R	CB164K
540	JCST 540QR	JCST 540QR-R	CB143K
715	JCST 715QR	JCST 715QR-R	CB159K
860	JCST 860QR	JCST 860QR-R	CB127K

### Additional JCST Models

- JCST with all the features described above are available for non-QR cable applications
- See chart below, or contact Ripley Company for custom sizing

Cable	Model Number Standard Handle	Part Number	Connector Manufacturer	Coring Bit Kit
8C	JCST GRS-8C-JS-PS-01	37495	Corning Gilbert	CB 246K
12C	JCST GRS-12C-JS-PS-01	37500	Corning Gilbert	CB 245K
12C	JCST GRS-12C-CH-LD-01-T	37505	Corning Gilbert	CB 248K
17C	JCST GRS-17C-CH-LD-01-T	37600	Corning Gilbert	CB 249K
17C	JCST GRS-17C-JS-PS-01	37605	Corning Gilbert	CB 250K
12C	JCST C12-PPC	37945	PPC	CB 248K
12C	JCST 12C-N	38040	NDK	CB 248K
12C	JCST 12C-K	38070	Kimura	CB 248K

# MWSS

## Messengered Web Slitter/Shaver



- MWSS is a *dual function* tool designed to:
  - First remove the cable messenger by *slitting* the web then,
  - *Shave* the residual web material leaving a smooth surface on the cable jacket
- Precise shaving of web material allows for proper cable preparation using a standard jacket stripping or coring tool
- Alignment slot in cable tray insures precise shaving of the residual web material after the slitting operation
- Slitting blade is factory set, but shaving blade can be field adjusted as required
- Spring loaded blade shield secures the cable into the tray
- Blade shield designed to protect the user from injury and the blade from damage
- Replacement Slitter Blade: CB 209
- U.S. Patent No.: 6,427,331
- Length: 3.8 in (96 mm) • Weight: 6.7 oz (191 g)

# MWS

## Messengered Web Slitter

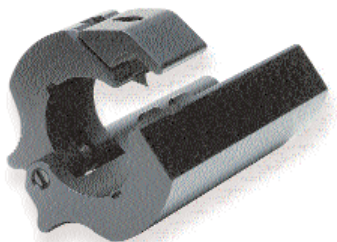

- MWS is ideal for applications that only require the *single function* of cable messenger web *slitting*, such as for pole clamp or dead-end attachment
- Made in U.S.A.
- Replacement Slitter Blades: CB 209
- Length: 3.8 in (96 mm) • Weight: 6.7 oz (191 g)

## Cable Application Reference Chart

Tool Model	Shaver Blade	CommScope® QR	CommScope® P3	Times Fiber T10	Times Fiber TX	Trilogy MC²
MWSS 400	CB229	QR 320	P3 412 JCAM	T10 412 MS		440 F8UA
MWSS 500	CB227	QR 500 QR 540	P3 500 JCAM P3 565 JCAM	T10 500 MS	TX 565 MS	500 F8UA
MWSS 700	CB226	QR 715	P3 625 JCAM P3 700 JCAM P3 750 JCAM	T10 625 MS T10 750 MS	TX 700 MS	650 F8UA
MWSS 800	CB228	QR 860	P3 840 JCAM P3 875 JCAM	T10 875 MS	TX 840 MS	750 F8UA
MWS 400	NA	QR 320	P3 412 JCAM	T10 412 MS		440 F8
MWS 500	NA	QR 500 QR 540	P3 500 JCAM	T10 500 MS	TX 565 MS	500 F8UA
MWS 700	NA	QR 715	P3 625 JCAM P3 750 JCAM	T10 625 MS T10 750 MS	TX 700 MS	650 F8UA 750 F8UA
MWS 800	NA	QR 860	P3 875 JCAM	T10 875 MS	TX 840 MS	

**Note: Use of MWSS Model is required to remove the residual web material on all messengered QR cables before connectorization.**

# CST-MC

## Trilogy Coring & Stripping Tools



- Specifically designed for Trilogy MC<sup>2</sup> cables
- Manual or drill operation; CST tools have a standard "T" handle with a built-in 3/8 inch (9.5 mm) drill adapter; CST-R tools have a ratchet "T" handle and a separate 3/8 inch (9.5 mm) drill adapter
- Double helix coring bit designed for fast and precise coring and stripping of polyethylene disc/air dielectric cable
- Heat treated, sheath cutting blade produces a smooth, beveled edge and can be replaced without the expense of replacing the entire coring bit
- Use of CC-100 or CC-200 Center Conductor Cleaner/Scraper removes residual dielectric which remains on the conductor after coring and stripping
- Length: 8.38 in (213 mm)
- Weight: 1 lb (454 g)

### Double helix coring & stripping bit

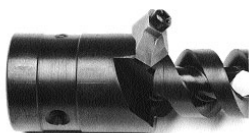

**.440 - .750 (11.18 mm - 19.05 mm) Cable**

Sheath Cutting Blade: CB 60

**1.000 (25.4 mm) Cable**

Sheath Cutting Blade: CB 60

## CST-MC Trilogy Coring & Stripping Tools

Cable	Model Number Standard Tool*	Guide Sleeve	Coring Bit Kit
440	CST 440MC	33771-1	CB 131K
500	CST 500MC	33771-2	CB 132K
650	CST 650MC	33771-3	CB 133K
750	CST 750MC	33771-4	CB 134K
1000	CST 21000MC	33777	CB 157K

\* Ratchet tool models are the same, with a "-R" suffix.  
Sleeve color: White

# CST PB10

## CST Tools for Coring and Stripping Trilogy PERFECTBONDED 10™ (PB10) Coaxial Cable

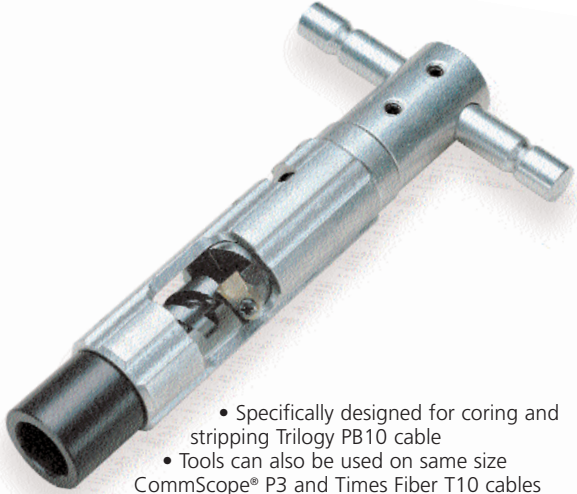

- Specifically designed for coring and stripping Trilogy PB10 cable
- Tools can also be used on same size CommScope® P3 and Times Fiber T10 cables
- Manual or drill operation, CST PB10 tools have a standard "T" handle with a built-in 3/8" (9.5 mm) drill adapter; CST PB10-R tools have a ratchet "T" handle and a separate 3/8 inch (9.5 mm) drill adapter
- Double helix coring bit design assures fast and precise coring of polyethylene disc/air dielectric cable design
- Heat treated sheath cutting blade produces a smooth, beveled edge and can be replaced without the expense of replacing the entire coring bit
- Use of CC-100 or CC-200 Center Conductor Cleaner/Scraper removes residual dielectric from center conductor
- Replacement Sheath Cutting Blade: CB 60
- Made in U.S.A.
- Length: 8.4 in ( 213 mm)
- Weight: 1 lb (454 g)

Cable	Model Number Standard Tool*	Guide Sleeve	Coring Bit Kit
500	CST 500 PB10	37251	CB 240K
625	CST 625 PB10	37252	CB 239K
750	CST 750 PB10	37253	CB 238K
875	CST 875 PB10	37254	CB 241K

\* Ratchet tool models are the same, with a "-R" suffix.  
Sleeve color: Black

## CC-100

### Center Conductor Cleaner

## CC-200

### Center Conductor Scraper

- For removing residual dielectric from the conductor of all sizes of trunk and distribution cables (without scratching or nicking)
- Finger grippers permit application of maximum force
- CC-100 has clear Plexiglas® multiple V-shaped cleaning notches
- CC-200 is supplied with clear Plexiglas® straight edged scraping blades
- "High visibility" red (CC-100) and yellow (CC-200) tool bodies
- Replacement cleaning blades fit either tool  
Part Number 16722, multiple "V" notched blade kit  
Part Number 16725, clear Plexiglas® scraping blade kit
- Length: 4.25 in (108 mm)
- Weight: 2.0 oz (57 g)



**CC-100**



**CC-200**

# CXC, CXC-1

## Cable Cutters

- CXC effective for cutting up to .75 inch (19 mm) trunk and distribution coaxial cable and copper cable
- CXC-1 cuts up to 1.00 inch (25.4 mm) trunk and distribution coaxial cable and copper cable
- Cuts with no cable distortion
- Lightweight, easy to use, compact
- Length: 8.00 in (203 mm)
- Weight: 11 oz (312 g)



# “CC” SERIES

## Cable Cutters / Stripper

- Designed to cut and strip solid & stranded copper and aluminum conductor
- Designed to minimize flattening of the cable end
- Preformed rounded jaws automatically position the cable for optimum cutting
- Precision, high quality carbon steel construction
- Durable, dipped non-slip handles



Application	Model	Wire Size Max (inches)	Approx. AWG Wire Size	Tool Length	Tool Weight
Cutting	CC22	.350	1	6-3/8 inches	6 oz (170 g)
	CC38	.430	2/0	8-1/4 inches	10.4 oz (296 g)
	CC60	.510	3/0	9-3/8 inches	12.4 oz (352 g)
Stripping	CC22	.230	4		
	CC38	.290	2		
	CC60	.330	1		

# SLT

## Stripping Tools for European Coaxial Cable

- Precise and easy two-step cable preparation
- Works on Slimline, F, FB and 2.2/9.3 FPE cables
- Adjustable strip stops cover a wide range of connector cable preparation dimensions:
  - Center conductor exposure from 10 mm to 20 mm
  - Braid exposure from 10 mm to 25 mm
- Rugged all metal construction
- Replacement blades —  
First cut: CB 35,  
Second cut: CB 6667
- Length: 8.625 in (219 mm)
- Weight: 1 lb 13 oz (817 g)

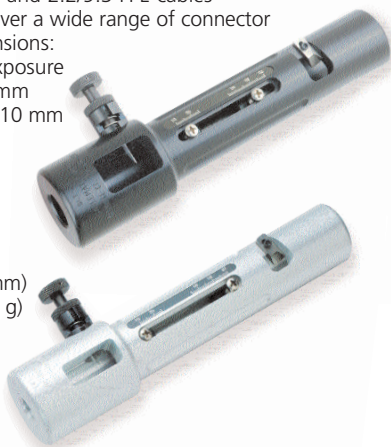

Tool	Cable Manufacturer	Cable Type	Color	Part Number
SLT 10.5	CommScope TKF, AEG Draka	Coax 6 CL 1.7/7.0	Orange	38405
		Coax 6 Bamboo	Orange	38405
		Coax 6 CT15A, CT165, CT175	Orange	38405
		IKx	Orange	38405
SLT 11	Belden/CDT	Coax 6 FB11	Purple	38610
SLT 12.5	Draka	Coax 4 CT 22S (2.2/8.8/12.3)	Red	37280
		Coax 4 CT 22A (2.2/8.8/12.3)	Red	37280
	Draka	Coax 4 CT 22A (2.2/9.3/12.5)	Red	37280
		Coax 4 CT 22E (2.2/9.3/12.5)	Red	37280
	AEG	AEG 2.2/8.8/12.5	Red	37280
	Bedeia	nKx A-2YOK2Y 1x(2.2/8.8)KxLg	Red	37280
SLT 14	Belden/CDT	Coax 4 FB14	Silver	37275
	Belden/CDT	Coax 4 F14	Silver	37275
	Beta Cavi	Coax 4 (2.2/10.2/13.6)	Silver	37275
	Draka	Coax 4 CT22A (2.2/10.2/13.6)	Silver	37275
SLT 15	Beta Cavi	N115 C (2.7/1.5/15.0)	Light Blue	38810
SLT 17	Draka	Coax 3 CT 33A (3.3/13.5/17.1)	Blue	38365
		Coax 3 CT 33S (3.3/13.3/17.1)	Blue	38365
	Bedeia	qKx (Bamboo type, 3.3/13.5/17.0)	Blue	38365
		A-2YOK2Y 1x(3.3/13.5)KxLg	Blue	38365
SLT 18	Belden/CDT	Coax 3 F18	Green	37278
SLT 20	Belden/CDT	Coax 3 FB20	Black	37270
	Belden/CDT	Coax 3 F20	Black	37270
	Beta Cavi	Coax 3	Black	37270
	Draka	Coax 3 CT 33A (3.45/14.9/19.3)	Black	37270
	Draka	Coax 3 CT 33E (3.45/14.9/19.3)	Black	37270
SLT 17.7	CommScope TKF/AEG	Coax 3 CL 3.3/13.5/17.7	Yellow	38400
		Coax 3 Bamboo	Yellow	38400
SLT 21	Belden/CDT	Coax 3 FB21	Bronze	38605
CB35	Replacement Blade First Cut	CB35		
CB6667	Replacement Blade Second Cut	CB66667 H		

# TXFF, TXFF-Q

## Flexible Feeder Stripping Tool

- For Times Fiber Communications (TFC) "Flexible Feeder" (TX10-15 Low Loss Drop Feeder) Cable and F50 CommScope cable
- Color coded and labeled for ease of proper tool identification  
Green - for Standard cable construction  
Blue - for Quad Shield cable construction
- The first cut (1st cut) will prepare cable to proper center conductor length. The second cut (2nd cut) will remove the proper length of outer jacket exposing the braid
- Replacement Blades — 1st cut: CB 26, 2nd cut: CB 60
  - Length: 5-3/8 inch (137 mm)
  - Weight: 1 lb. 12 oz. (795 g)



Model	Color	Cable	Connector
TXFF-C	Green	Standard	Corning Cabelcon
TXFF-QC	Blue	Quad	Corning Cabelcon
TXFF-A/G	Green	Standard	Amphenol & Corning Gilbert
TXFF-QA/G	Blue	Quad	Amphenol & Corning Gilbert
TXFF-P	Green	Standard	PPC & PCT
TXFF-QP	Blue	Quad	PPC & PCT

Note: Please call our Customer Service Department for connector manufacturers not listed above.

# SDT-TXFF

## Flexible Feeder Single Drop Trimmer

- Single Drop Trimmer for Times Fiber Communications (TFC) "Flexible Feeder" (TX10-15 Low Loss Drop Feeder) Cable and F50 CommScope cable
- ONE STEP cable preparation for smooth, precise cuts removing both the jacket and the dielectric
- Prepares cable for all major connector manufacturers to 1/2" or 1" (12.7 or 25.4 mm) center conductor length and 1/4" (6.35 mm) braid preparation
- Ergonomic, lightweight design
- U.S. Patent Nos.: 6,128,976 and 6,253,641
- Length: 4.6 inch (119 mm)
- Weight: 1.9 oz (54 g)



# CST 320/7C QRF

## Coring & Stripping Tool for "F" Type Connectorization

- Specifically designed for coring and stripping MDU 320 CommScope® Quantum Reach® (QR) cables
- Tools factory set to core and strip required preparation dimensions for Corning Gilbert ULTRASEAL™ 320 QR and GAF-360-320, PCT-DRS 320 QR, PPC EX320 QR, and Thomas & Betts Snap-N-Seal® 320 QR "F" connectors
- Simple, three-step operation:
  1. Core and strip the cable end
  2. Remove center conductor residual dielectric with the **built-in center conductor cleaner**
  3. Other end of tool will remove proper length of outer jacket while chamfering the center conductor
- Heat treated coring bit and cutting blades for long lasting life
- Manual operation only
- Made in U.S.A.
- Replacement Coring Bit: CB 216
- Replacement Sheath Cutting Blade: CB 60
- Replacement Jacket Cutting Blade: CB 60
- Replacement Conductor Cleaner Kit: CC-320QRF
- Connector assembly tools use:
  - CR41Q for Corning Gilbert GAF-360-320
  - CAT-AS for PPC EX320QR, Corning Gilbert ULTRASEAL™ 320QR and PCT-DRS 320QR
- Length: 5 in (127 mm)
- Weight: 8 oz (227 g)



# UT

## Drop Cable Trimmers

- For foam or solid dielectric cable preparation
- Precision, two-step operation, no nicks or scratches
- Exact cable specific, connector specific cable preparation
- U.S. Patent No.: 3,659,483
- Length: 2 to 3 in (51 to 76 mm)
- Weight: 2.25 to 3.25 oz (64 to 92 g)



Cable	Model	Connector Type	First Cut (inches)	2nd Cut (inches)	Replacement Blade	Body Color
RG58/U	UT 5800	PL-259	25/32 jacket strip	21/32 center conductor strip	CB 60	Green
RG59/U	UT 5901	PL-259 or TV Wall Plate	27/32 jacket strip	23/32 center conductor strip	CB 60	Red
RG59/U	UT 5902	CP-88	13/32 jacket strip	11/32 center conductor strip	CB 60	Grey
RG8/U, 213/U	UT 8000	PL-259	5/8 center conductor strip	21/32 jacket strip	CB 60A	Gold

# DDT

## Dual Drop Trimmer

**NEW**  
for 2006

- **Small Combo Body**

**Design** that allows cable preparation of 59,6, N48 and 11 coax cable (std,tri and quad) without any adjustment or blade cassette change out

- **One Step cable preparation**

precisely exposes the center conductor by 5/16" (7.93mm) and removes the proper length of jacket at 1/4" (6.35mm)

- Built-in strip stop for precise preparation every time

- Lightweight, impact resistant "High-Visibility" yellow polymer construction

- **DDT can be supplied with a Mini Coax Cable cassette** in place of 11 cassette — See table for models available

- Superior quality tool steel blade cassettes will perform 1500+ preparations under normal use

- Blade cassettes color-coded and marked with cable series type for easy identification

- **Note:** Tool is not intended for Plenum Series Cable Construction

- US Patent No.:5,713,132

- Length: 3.63in (92.08mm) • Weight: 2.0 oz (57g)



Model	Drop Cable Series
DDT-596/11	For 59, 6, N48, 11 Coax Cable
DDT-EUR/11	For 59, 6, N48, Coax 9 and 11 Coax Cable
DDT-596/MINI	For 59, 6, N48, MINI and N35 Coax Cable
DDT-5C/MINI	For 5C, MINI N35 Coax Cable
DDT-COAX9/MINI	For Coax 9, MINI and N35 Coax Cable
DDT-EUR/MINI	For 59, 6, N48, Coax 9, MINI and N35 Coax Cable

## DDT MINI model will prepare the following cables:

MINI Cable Manufacturer	Cable Identification
Belden	YR 469940
Belden	1855
Belden	1855A
Beta Cavi	N35
CommScope	7538
CommScope	7538B
CommScope	7539/7539H
CommScope	73501S
Times Fiber	T75M67T-VBV
Times Fiber	T75MQ65/40-VBV

Note: Please call Customer Service for cable manufacturers not listed.

Replacement Blade Cassettes	Drop Cable Series	Color
RC596-250	59, 6 and N48	Red
RC11-250	11	Black
RC EUR-250	59, 6, N48 and Coax 9	Orange
RC MINI-250	MINI and N35	White
RC596-250PB	5C	Blue
RC9-250	Coax 9	Green

# LDT

## Lightweight Drop Trimmer

**NEW  
for 2006**

- **Lightweight and Compact Body Design** that allows cable preparation of 59,6 and N48 coax cable (std, tri and quad) without any adjustment or blade cassette change out
- **One Step cable preparation** precisely exposes the center conductor by 5/16" (7.93mm) and removes the proper length of jacket at 1/4" (6.35mm)
- Built-in strip stop for precise preparation every time
- Lightweight, impact resistant "High-Visibility" yellow polymer construction
- **LDT can be supplied with other blade cassettes – see table for models available**
- Superior quality tool steel blade cassettes will perform 1500+ preparations under normal usage
- Blade cassettes color-coded and marked with cable series type for easy identification
- **Note:** Tool is not intended for Plenum Series Cable Construction
- Length: 4 in (102 mm)
- Weight: 0.8 oz (23 g)



Model	Drop Cable Series	Replacement Cassettes	Color
LDT596-250	59,6 and N48	RC596-250	Red
LDT5C-250	5C	RC596-250PB	Blue
LDT COAX 9	Coax 9	RC9-250	Green
LDT EUR	59, 6, N48 and Coax 9	RCEUR-250	Orange
LDT MINI	MINI and N35	RCMINI-250	White

### LDT MINI model will prepare the following cables:

MINI Cable Manufacturer	Cable Identification
Belden	YR 46940
Belden	1855
Belden	1855A
Beta Cavi	N35
CommScope	7538
CommScope	7538B
CommScope	7539/7539H
CommScope	73501S
Times Fiber	T75M67T-VBV
Times Fiber	T75MQ65/40-VBV

Note: Please call Customer Service for cable manufacturers not listed.

# UDT

## Universal Drop Trimmer

- Prepares ALL 59, 6, N48, 7, 11 drop cable constructions as per SCTE and Bellcore specifications
- ONE STEP cable preparation exposes the center conductor and removes the jacket
- Built-in strip stops
- ONE TOOL, with inter-changeable blade cassettes, will perform all the following cable industry standard preparations:
  - 1/4" (6.35 mm) Braid preparation for Series 59, 6, N48, 7, 11 cable
  - 1/8" (3.18 mm) Braid preparation for Series 59, 6, N48, 7, 11 cable (NOTE: Tool is not intended for Plenum Series Cable Construction)
- Cassettes available for 1/4" (6.35 mm) or 1/8" (3.18 mm) cable preparation:

Series 59/6, N48	Standard, Tri and Quad Shield cables
Series 7	Standard, Tri and Quad Shield cables
Series 11	Standard, Tri and Trilogy Quad Shield cables
Series 11Q	Belden, CommScope® and Times Fiber Quad Shield cables
- Blade cassettes color-coded and marked with cable series type and braid preparation dimensions for easy identification
- Unique cassette storage compartment holds two extra cassettes
- High impact, "Hi-Visibility Red", polymer construction
- Compact size fits in one hand
- Series 59, 6, N48 cassettes are to be used in tool cavity Side (A) only, Series 7, 11 and 11Q in the opposite cavity only
- No adjustments or extra tools required
- Made in the U.S.A.
- U.S. Patent No.: 5,713,132
- Length: 5.5 in (139.7 mm)
- Weight: 4.5 oz (127 g)

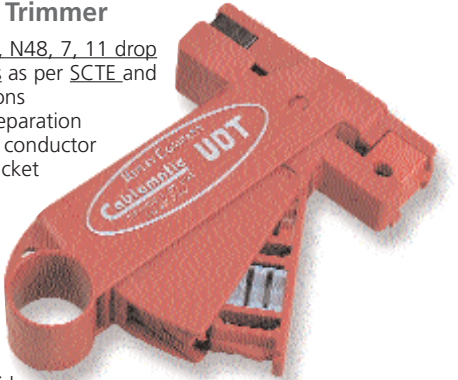



# SDT

## Single Drop Trimmer

- **ONE STEP** cable preparation precisely exposes the center conductor and removes the proper length of jacket to SCTE and Bellcore specifications
- **NEW...** now also available with a built-in strip stop — see model SDT596-250SS (SDT596-250 is standard tool)
- **SMALL ERGONOMIC BODY DESIGN** fits into your hand for ease of use and comfort, as well as your tool pouch
- Tool body constructed of **LIGHTWEIGHT**, impact resistant “Hi-Visibility Red” polymer
- No adjustments or extra tools required
- **NOTE: Tool is not intended for Plenum Series Cable construction**
- Select models for either .250 (1/4) braid preparation or .125 (1/8) braid preparation
- Superior quality tool steel blade cassettes will perform 1500+ preparations under normal use
- Tool supplied with model specified cassette assembled in tool and one spare cassette
- Unique “Cassette Ejector” provides quick blade cassette removal
- Replaceable blade cassettes are color-coded and marked with cable series type and braid preparation dimensions for easy identification
- The various SDT models are cable specific... model SDT596-250 is for 59, 6, and N48 series cable only, SDT11-250 is for 11 series cable only, SDT596-250PB is for 5C series cable only, SDT Coax 9 for Coax 9 only and SDT EUR is for 59, 6, N48 & Coax 9 cable only (NOTE: Cassettes are not interchangeable between models)
- Made in the U.S.A.
- U.S. Patent Nos.: 6,128,976 and 6,253,641
- Length: 4.6 in (119 mm)
- Weight: 1.6 oz (45 g)

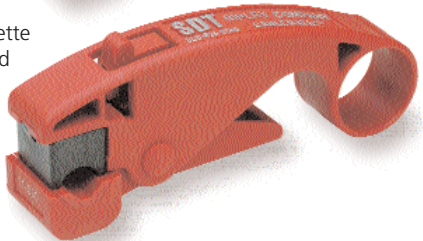
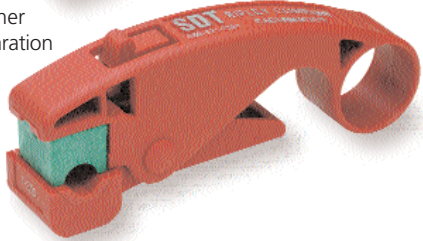

# SINGLE DROP TRIMMER ORDERING GUIDE

For .250 (1/4") 6.4 mm Cable Preparation



Model	Drop Cable Series	Replacement Cassettes	Color
SDT596-250	59, 6, Std. Tri & Quad, N48	RC596-250	Red
SDT596-250SS	59, 6, Std. Tri & Quad, N48	RC596-250	Red
SDT7-250	7 Std. Tri & Quad	RC7-250	Green
SDT11-250*	11 Std. Tri & Quad	RC11-250	Black
		RC11Q-250	Gray
SDT596-250PB	5C	RC596-250PB	Black
SDT EUR	59, 6, Std. Tri & Quad, N48, Coax 9	RCEUR-250	Orange
SDT Coax 9	Coax 9	RC9-250	Green

\*SDT model supplied with 11 (Black) cassette for use on 11 standard and Tri Shield cable and 11Q (gray) cassette for use on 11 Quad Shield cable.

# SINGLE DROP TRIMMER ORDERING GUIDE

For .125 (1/8") 3.2 mm Cable Preparation



Model	Drop Cable Series	Replacement Cassettes	Color
SDT596-125	59, 6, Std. Tri & Quad, N48	RC596-125	Blue
SDT596-125SS	59, 6, Std. Tri & Quad, N48	RC596-125	Blue
SDT7-125	7 Std. Tri & Quad	RC7-125	Tan
SDT11-125**	11 Std. Tri & Quad	RC11-125	Yellow
		RC11Q-125	Orange

\*\* SDT model supplied with 11 (yellow) cassette for use on 11 Standard and Tri Shield cable and 11Q (orange) for use on 11 Quad Shield cable.  
Note: Replacement Blade Cassettes (2 cassettes per package)

# DCS

## Drop Cable Slitter

- Designed to slit the web on 59, 6, 7, & 11 series messengered and dual cables in the following cable configurations:
  - Messengered coaxial drop cable
  - Dual coaxial drop cable
  - Dual coaxial messengered drop cable
  - Dual coaxial and twisted pair cable
  - Dual messengered coaxial and twisted pair cable
- Provides a clear view of slitting action
- Works on PVC and Polyethylene jackets
- Built-in saddle and spring loaded jaw permits easy positioning of cable
- Built-in shaving blade removes residual ridge material allowing easy connectorization
- No blade adjustments required
- Ergonomic, user-friendly design
- Lightweight and compact, fits in the palm of your hand for easy one hand operation
- High visibility red color
- Replacement Blades — Slitting: CB 209, Shaving: CB 210
- Made in U.S.A.
- Length: 2.75 in (70 mm)
- Weight: 5 oz (140 g)
- U.S. Patent No.: 6,131,289

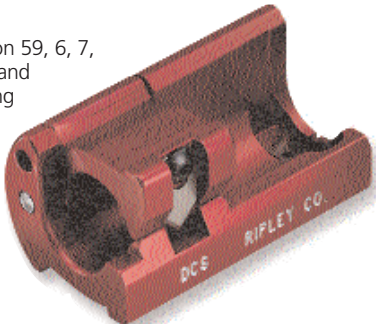

# CR

## Hex Crimp Tool

- For CATV, MATV and STV type cable connectors
- Precision quality alloy steel jaws are self-bottoming and will not over-crimp
- Toggle action delivers correct crimping force
- Rugged components for long, trouble-free performance
- Star wheel permits precise, easy compression adjustment
- Easy-to-read hex sizes stamped on frame
- Full-cushion handles will not slide off
- Rugged steel frame with heat treated pins for maximum strength and operating life
- Length: 9.00 in (229 mm)
- Weight: 1 lb 9 oz (708 g)



## ORDERING GUIDE FOR CR TOOLS

### CATV / MATV / STV CABLES

Model	Hex Size		Contact Hex			
	(inch)	(mm)	(inch)	(mm)	(inch)	(mm)
CR 211CX	.475	12.07	.096	2.43	-	-
CR 324	.324	8.23	.068	1.73	-	-
CR 360	.360	9.14	-	-	-	-
CR 41Q	.453 / .315	11.15 / 8.00	-	-	-	-
CR 42Q	.320 / .250	8.13 / 6.35	-	-	-	-
CR 43Q	.435/.327/.295	11.05/8.31/7.49	-	-	-	-
CR 470/410	.470 / .410	11.94 / 10.41	-	-	-	-
CR 596B	.324 / .262	8.23 / 6.65	-	-	-	-
CR 596Q	.384 / .324	9.75 / 8.23	-	-	-	-
CR 596QL	.360 / .324	9.14 / 8.23	-	-	-	-
CR 596QL2	.360 / .324	9.14 / 8.23	0.068	1.73	-	-
CR 596-11	.410 / .324	10.41 / 8.23	-	-	-	-
CR 611Q	.475 / .324	12.07 / 8.23	-	-	-	-
CR 611QL	.470 / .324	11.94 / 8.23	-	-	-	-
CR 611Q2	.475 / .324	12.07 / 8.23	.100	2.54	-	-
CR 611U	.475 / .360	12.07 / 9.14	.096	2.43	-	-
CR 756	.410 / .360	10.41 / 9.14	-	-	-	-

### COMMUNICATION CABLES

Model	Hex Size		Contact Hex					
	(inch)	(mm)	1		2		3	
			(inch)	(mm)	(inch)	(mm)	(inch)	(mm)
CR 255U	.255 / .213	6.48 / 5.41	.100	2.54	.068	1.73	.050	1.27
CR 314	.314	7.98	.068	1.73	-	-	-	-
CR 589B	.314 / .248	7.98 / 6.30	.050	1.27	-	-	-	-
CR 770	.429 / .213	10.90 / 5.41	.100	2.54	.068	1.73	-	-

### CRMK-1 MAINTENANCE KIT FOR CRIMP TOOLS

Kit includes:

- 1 star wheel, 1 star wheel screw, 2 links, retaining rings, pins & caps, bow washers, 1/16" hex wrench

## CR-AL

### Aluminum Superlite Crimp Tools

- Superlite high grade blue anodized aluminum crimp tool
- Both the crimp frame and the handle are made of Superlite aluminum
- It's really light... 58% lighter than our standard steel CR series of crimp tools
- Same high quality features as our standard CR series
- The CR-AL will maintain its durability and reliability at 58% less weight
- Models available: CR360-AL and CR596QL-AL
- Length: 9" (229 mm)
- Weight: 14.7 oz. (420 g)



## CR-Ratchet

### Full Cycle Crimp Tools

- For ensuring a full cycle, full connector termination; ratchet-type mechanism prevents early release
- Same quality features as the standard CR Series crimp tool
- Escapement lever mechanism is easily accessible
- Length: 9.00 in (229 mm)
- Weight: 1 lb 10 oz. (737 g)



Model	Hex Sizes	
	(inch)	(mm)
CR 360-R	.360	9.14
CR 596Q-R	.384 / .324	9.75 / 8.23
CR 596QL-R	.360 / .324	9.14 / 8.23
CR 211CX-R	.475 / .096	12.07 / 2.43
CR 611U-R	.475 / .360 / .096	12.07 / 9.14 / 2.43
CR 611Q2-R	.475 / .324 / .100	12.07 / 8.23 / 2.54

# Compression Assembly Tools

- Tools designed for 6 & 59 compression connectors
- Field proven - high strength cast aluminum body
- Tools provide a clear view of the connector assembly compression action
- Spring loaded, split jaws position the cable and connector for easy insertion and removal
- Ergonomic, user friendly design
- U.S. Patent Nos.: 5,934,137 and 5,647,119
- Length: 7 in (178 mm) • Weight: 1 lb (454 g)

## CAT-Universal

- Configured with the "Universal" plunger tip, factory preset and calibrated to assemble the following connectors:
  - Arris - Digicon-S™ & T™
  - Corning Cabelcon-CX3
  - Corning Gilbert ULTRAEASE™
  - Corning Gilbert ULTRARANGE™
  - F-Conn-FS
  - PCT - DRS
  - PPC - EX XL, CMP
  - Thomas & Betts SNAP-N-SEAL®
  - Holland SLC
- Plunger tip can be changed out to allow assembly of other compression connectors (EX and SPL)
- Calibration/ gauge block and hex wrench supplied with tool



## CAT-Universal-FX

- FX model tool has same "Universal" plunger tip as the Universal Model but is **"fixed"** (plunger tip factory set, calibrated, and **non-adjustable**)
- Assembles the same connectors as the CAT-UNIVERSAL
- FX model does not allow future plunger tip changeover



## ORDERING GUIDE FOR CAT COMPRESSION ASSEMBLY TOOLS

CAT Model	6/59 SERIES	7 SERIES	11 SERIES	Plunger Tip Color Code
CAT-UNIVERSAL & CAT-UNIVERSAL-FX	Arris-Digicon DS & DT™ Corning Cabelcon-CX3 Corning Gilbert F-UE, F-UE-M, Corning Gilbert ULTRARANGE™ F-Conn-FS	Holland SLC PCT-DRS PPC-EX XL PPC-CMP Thomas & Betts SNAP-N-SEAL®		Green
CAT-EX	PPC EX	PCT-TRS		Black
CAT-SPL	STIRLING-SPL			Gray
CAT-IEC/RCA-FX	Arris-Digicon DS & DT™, DS-RCA Corning Cabelcon-CX3 Corning Cabelcon-CX3-IECF Corning Cabelcon-CX3-IECM Corning Gilbert F-UE, F-UE-M, RCA-UE, RCA-UE-M Corning Gilbert ULTRARANGE™ F-Conn-FS, FSC	Holland SLC PCT-DRS PCT-DRS-IECF PCT-DRS-IECM PPC CMP-MC, CMP-RCA, CMP-IEC PPC-EX XL PPC-CMP Thomas & Betts SNAP-N-SEAL®		

# LWC, LWC-1

Lightweight Compression Assembly Tool

**NEW**  
for 2006



- Lightweight, impact resistant “High-Visibility” yellow polymer design
- **Assembles 6 and 59 series low compression connectors only – see table for listing**
- Spring loaded split jaws position the cable and the connector for easy insertion and removal
- Tool is fully insulated with the use of all polymer components (LWC-1 is not fully insulated)
- Easy to use around cable assemblies where space and cable may be limited
- Tool secures cable assembly a full 360 degrees ensuring linear cable to connector compression each and every time
- Tool factory preset and calibrated and is non-adjustable
- **LWC-1** assembles the same low compression connectors as the LWC with the addition of the PPC-MC (Mini Connector). LWC-1 is supplied with a magnetic adapter that is placed on the end of the plunger tip to assemble the PPC-MC connector. The adapter is securely stored in the tool handle when not in use
- Length: 5.8 in (147 mm)
- Weight: 4.5 oz (128 g)

Connector Manufacturer	Connectors
Corning Gilbert	ULTRAease- F-UE, F-UE-M, RCA-UE, RCA-UE-M
PPC	CMP-F, CMP-RCA, CMP-IEC, CMP-MC ( with LWC-1 only)
T&B	SNAP & SEAL SNS1P59/6 Series
Holland	SLC6

# CAT-AS "All Series"

## Compression Assembly Tool

- Unique CAT allows assembly of Series 59/6, 7, and 11 drop connectors in one versatile tool
- Two sets of jaws, precision designed – one set for 59 & 6 connectors, and another set for 7 & 11 connectors
- Field proven design based on original Cablematic® CAT design with high strength cast aluminum body
- Spring loaded, split jaws position the cable and connector for easy insertion and removal
- Available in a "fixed" model (CAT-AS-FX) with a fixed, factory set plunger tip that is non-adjustable.
- U.S. Patent Nos.: 5,934,137 and 5,647,119
- Length: 7.4 in (187 mm)
- Weight: 1.1 lb (500 g)

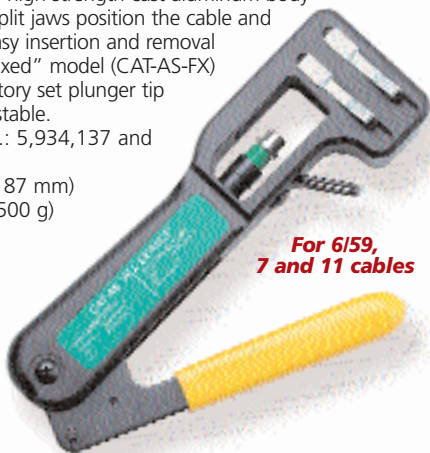

**For 6/59,  
7 and 11 cables**

## ORDERING GUIDE FOR CAT-AS COMPRESSION ASSEMBLY TOOLS

CAT-AS Model	6/59 SERIES	7 SERIES	11 SERIES	Plunger Tip Color Code
CAT-AS & CAT-AS-FX	Arris-Digicon DS & DT™ Corning Cabelcon-CX3 Corning Gilbert F-UE, F-UE-M Corning Gilbert ULTRARANGE™ F-Conn-FS Holland SLC PCT-DRS PPC-CMP, PPC-EX XL Thomas & Betts SNAP-N-SEAL®	Arris-Digicon DS & DT™ Corning Gilbert ULTRASEAL™ PPC-EX Thomas & Betts SNAP-N-SEAL®	Corning Cabelcon-CX3 Corning Gilbert ULTRASEAL™ Corning Gilbert ULTRASEAL™ 320 QR PCT-DRS, PCT-DRS-320QR PPC-EX, PPC-EX320QR Thomas & Betts SNAP-N-SEAL®	Green
CAT-AS-EX	PCT-TRS PPC-EX, PPC-CMP-MC	PCT-TRS PPC-EX	Corning Gilbert ULTRASEAL™ 320 QR PCT-DRS, PCT-DRS-320QR PPC-EX, PPC-EX320QR	Black
CAT-AS-DIGICON & CAT-AS-DIGICON-FX	Arris-Digicon DS & DT™ Corning Cabelcon-CX3 Corning Gilbert F-UE, F-UE-M Corning Gilbert ULTRARANGE™ F-Conn-FS Holland SLC PCT-DRS PPC-CMP, PPC-EX XL Thomas & Betts SNAP-N-SEAL®	Arris-Digicon DS & DT™	Arris-Digicon DS & DT™	Gray
CAT-AS-IEC/RCA-FX	Arris-Digicon DS & DT™, DS-RCA Corning Cabelcon-CX3 Corning Cabelcon-CX3-IECF Corning Cabelcon-CX3-IECM Corning Gilbert F-UE, F-UE-M, RCA-UE, RCA-UE-M Corning Gilbert ULTRARANGE™ F-Conn-FS, F-Conn-FSC Holland SLC PPC-EX XL, PPC-CMP, PPC-CMP-RCA, PPC-CMP-IEC PCT-DRS, PCT-DRS-IECF PCT-DRS-IECM Thomas & Betts SNAP-N-SEAL®	Arris-Digicon DS & DT™ Corning Gilbert ULTRASEAL™ PPC-EX Thomas & Betts SNAP-N-SEAL®	Corning Cabelcon-CX3 Corning Gilbert ULTRASEAL™ Corning Gilbert ULTRASEAL™ 320 QR PCT-DRS, PCT-DRS-320QR PPC-EX, PPC-EX320QR Thomas & Betts SNAP-N-SEAL®	

## Other CAT Models

- Tools factory preset and calibrated to assemble either PPC-EX, Stirling SPL or PCT-TRS connectors
- Color coded plunger tip band and tool label for easy connector identification
- Plunger tip can be changed (CAT-Universal only) to allow assembly of any other compression connector
- Calibration/gauge block and hex wrench supplied with tool



## CAT-MULTIMEDIA

**NEW**  
for 2006

### Multimedia Compression Assembly Tool

- Compression tool design allows for quick and easy assembly of 59/6 "F" and manufacturer specific RCA and BNC connectors – see table for models available
- Field-proven design based on original Cablematic CAT series with high strength aluminum body
- Two sets of jaws, specifically positioned for 59/6 "F", RCA and BNC connectors
- Spring loaded, split jaws position the cable and connector for easy insertion and removal
- Fast and efficient cable assembly compression. User can go from assembling "F" type, RCA and BNC connectors with no special adapters or adjustments with Digicon/F-Conn, Gilbert and PPC models. An adapter is required for Holland, Liberty Wire & Cable and T&B models
- Tool is factory calibrated and set to provide the user with a truly fail safe assembly tool for the multimedia environment
- Compression tool body is color coded for ease of identifying the specific connector manufacturer
- U.S. Patent Nos: 5,934,137 and 5,647,119
- Length: 7.4 in (187 mm)
- Weight: 1.1 lb (500 g)



Model	Tool Color	Connector Manufacturer	Connectors 59/6
CAT-MULTIMEDIA	Red	Digicon & F-Conn	Digicon- DS, DT, DSU, DS-RCA, DS-RCA MINI, DS-BNC F-Conn- FS,FSU,FS-RCA,FSC-BNC
CAT-MULTIMEDIA	Bronze	Gilbert	F-UE,F-UE-M,RCA-UE, RCA-UE-M, BNC-UE, BNC-UE-M, ULTRARANGE F
CAT-MULTIMEDIA	Purple	Holland	SLC, SLC6-RCA, SLC6-BNC, SLC1855-RCA-FP, SLC1855-BNC, SLCM1855-FP2
CAT-MULTIMEDIA	Blue	PPC	CMP, EX-XL, CMP-RCA, CMP-BNC, EX-BNC
CAT-MULTIMEDIA	Gray	T&B	SNS1P "F" Series, SNS1P6RM Series (RCA), SNS-BNC Series (BNC)
CAT-MULTIMEDIA	Green	Liberty Wire & Cable	CM-F, CM-RCA, CM-BNC

# CAT-AIO

## All-in-One Compression Assembly Tool

- This all-in-one compression tool design allows for assembly of series 59/6, 7 and 11 drop connectors from most connector manufacturers (Arris/Telewire, Corning Cabelcon, Corning Gilbert, F-Conn, PCT, PPC and Thomas & Betts)
- Tool is supplied with 2 unique interchangeable plunger tips (IPT) that will assemble the majority of all the universal series of 59/6, 7 and 11 connectors as well as 59/6 PPC-EX and PCT-TRS. Thirteen additional IPT's are available for RCA, BNC, IEC and other F connector applications. For additional IPT applications, contact Ripley
- Tool is shipped with one interchangeable plunger tip (IPT 1A/1B) in the tool and has an extra plunger tip (IPT 2A/2B) conveniently stored within the tool body
- This tool allows the user to pick and choose only the additional plunger tips that are required for their unique applications
- Field-proven design based on original Cablematic® CAT series with high strength cast aluminum body
- Supplied with an SDT 596-250 coax stripper, a gauge block and hex wrench for tool calibration in its own plastic storage case
- Interchangeable plunger tips, tool body and tool case are clearly identified with all the appropriate connector types
- Easy tool calibration with supplied gauge block and star adjustment wheel on the handle
- U.S. Patent Applied For
- Length: 7.4 in (187 mm)
- Weight: 1.1 lb (500 g)



**2-sided IPT**

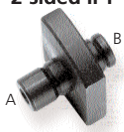

**1-sided IPT**



Note: IPT with a like number and a suffix A or B indicates that the plunger is 2-sided. The "A" side assembles connectors indicated and the "B" side assembles connectors indicated.

# ORDERING GUIDE FOR CAT-AIO COMPRESSION ASSEMBLY TOOL

**IPT with a like number and a suffix A or B indicates that the plunger is 2 sided.  
The A or B suffix indicates the connectors assembled.**

Plunger					
Tip Model	6/59 SERIES	7 SERIES	11 SERIES	RCA	BNC
IPT 1A	Arri-Digicon-DS & DT™ Coming Cabelcon-CX3 Coming Cabelcon-CX3-IECF Coming Cabelcon-CX3-IECM Coming Gilbert F-UE, F-UE-M Coming Gilbert-ULTRARANGE™ F-Conn-FS Holland SLC PCT-DRS, PCT-DRS-IECF PCT-DRS-IECM PPC-EX XL, PPC-EX-XLWS PPC-CMP, PPC-CMP-IEC Thomas & Betts SNAP-N-SEAL® Universal Series	Arri-Digicon-DS7™(feed thru)		Arri-Digicon-DS-RCA Coming Gilbert-RCA-UE Coming Gilbert-RCA-UE-M F-Conn-FS-RCA PPC-CMP-RCA	
IPT 1B		Coming Gilbert-ULTRASEAL™ PPC-EX Thomas & Betts SNAP-N-SEAL® Universal Series	Coming Cabelcon-CX3 Coming Gilbert-ULTRASEAL™ Coming Gilbert-ULTRASEAL 320QR PPC-EX, PPC-EX320QR Thomas & Betts SNAP-N-SEAL® Universal Series		
IPT 2A	PPC-EX, PPC-CMP-MC PCT-TRS				
IPT 2B			Arri-Digicon-DS & DT™ F-Conn-FS		
IPT 3A	Arri-Digicon-DS & DT™ Coming Cabelcon-CX3 Coming Cabelcon-CX3-IECF Coming Cabelcon-CX3-IECM Coming Gilbert F-UE, F-UE-M Coming Gilbert-ULTRARANGE™ F-Conn-FS Holland SLC PCT-DRS, PCT-DRS-IECF PCT-DRS-IECM PPC-EX XL, PPC-EX-XLWS PPC-CMP, PPC-CMP-IEC Thomas & Betts SNAP-N-SEAL® Universal Series	Arri-Digicon-DS7™(feed thru)		Arri-Digicon-DS-RCA Coming Gilbert-RCA-UE Coming Gilbert-RCA-UE-M F-Conn-FS-RCA PPC-CMP-RCA	
IPT 3B				Thomas & Betts SNAP-N-SEAL®	
IPT 4					Thomas & Betts SNAP-N-SEAL®
IPT 5					Coming Gilbert-BNC-UE, BNC-UE-M
IPT 6					Arri-Digicon-DS & DT™ F-Conn-FSC
IPT 7					PPC-EX, PPC-CMP
IPT 8A	PPC-EX, PPC-CMP-MC PCT-TRS				
IPT 8B		Coming Gilbert-ULTRASEAL™ PPC-EX Thomas & Betts SNAP-N-SEAL® Universal Series	Coming Cabelcon-CX3 Coming Gilbert-ULTRASEAL™ Coming Gilbert-ULTRASEAL 320QR PPC-EX, PPC-EX320QR Thomas & Betts SNAP-N-SEAL® Universal Series		
IPT 9A	Arri-Digicon-DS & DT™ Coming Cabelcon-CX3 Coming Cabelcon-CX3-IECF Coming Cabelcon-CX3-IECM Coming Gilbert F-UE, F-UE-M Coming Gilbert-ULTRARANGE™ F-Conn-FS Holland SLC PCT-DRS, PCT-DRS-IECF PCT-DRS-IECM PPC-EX XL, PPC-WX-XLWS PPC-CMP, PPC-CMP-IEC Thomas & Betts SNAP-N-SEAL® Universal Series	Arri-Digicon-DS7™(feed thru)		Arri-Digicon-DS-RCA Coming Gilbert-RCA-UE Coming Gilbert-RCA-UE-M F-Conn-FS-RCA PPC-CMP-RCA	
IPT 9B			Arri-Digicon-DS & DT™ F-Conn-FS		

**CONTINUED ON NEXT PAGE....**

# ORDERING GUIDE FOR CAT-AIO COMPRESSION ASSEMBLY TOOL (CONTINUED)

**IPT with a like number and a suffix A or B indicates that the plunger is 2 sided.  
The A or B suffix indicates the connectors assembled.**

Plunger					
Tip Model	6/59 SERIES	7 SERIES	11 SERIES	RCA	BNC
IPT 10A	Aris-Digicon-DS & DT™ Corning Cabelcon-CX3 Corning Cabelcon-CX3-IECF Corning Cabelcon-CX3-IECM Corning Gilbert F-UE-M Corning Gilbert-ULTRARANGE™ F-Conn-FS Holland SLC PCT-DRS, PCT-DRS-IECF PCT-DRS-IECM PPC-EX XL, PPC-EX-XLWS PPC-CMP, PPC-CMP-IEC Thomas & Betts SNAP & SEAL® Universal Series	Aris-Digicon-DS7™(feed thru)		Aris-Digicon-DS-RCA Corning Gilbert-RCA-UE Corning Gilbert-RCA-UE-M F-Conn-FS-RCA PPC-CMP-RCA	
IPT 10B	PPC-EX, PPC-MC PCT-TRS				
IPT 11A		Aris-Digicon-DS7P (pin type)			
IPT 11B			Aris-Digicon-DS & DT™ F-Conn-FS		
IPT 12					Corning Cabelcon
IPT 13A	Holland SLCM-1855FP				
IPT 13B	Holland SLCM-1855IEC				
IPT 14A	Stirling SPL				
IPT 14B		Corning Gilbert-ULTRASEAL™ PPC-EX Thomas & Betts-SNAP-N-SEAL® Universal Series	Corning Cabelcon-CX3 Corning Gilbert-ULTRASEAL™ Corning Gilbert-ULTRASEAL 3200R PPC-EX, PPC-EX3200R Thomas & Betts-SNAP-N-SEAL® Universal Series		
IPT 15A	Holland SLCM-1855FP				
IPT 15B			Holland SLC11		

# RTT

## Round Taper Tool

- Unique spring loaded split jaw design allows **FAST & EASY insertion, compression and removal** of cable assembly
- Tool designed to be used with the following 360° Conical "Swedge" Connectors:
  - Arris/Telewire Digicon® Type II Series 6 & 59
  - F-Conn RG radial type compression connector
- Toggle action allows minimal hand force and maximum strength to complete connector assembly
- Rugged, steel "O" Frame design with heat treated components, assures long operating life
- Unique adjustment features provide cable connector assembly reliability
- Full Cycle ratchet mechanism, with easy access escape lever, assures a complete assembly each and every time
- Improved HIGH VISIBILITY yellow cushion grips provide more comfort and like our original design will not rotate or slip during use
- Made in the U.S.A., U.S. Patent No.: 5,392,508; 5,596,800; 5,743,131; & 6,112,404
- Length: 11.50 in (292 mm) • Weight: 2.06 lbs (917 g)



# TW Torque Wrenches

*All our quality torque wrenches share many of the same features including...*

- Prevent damage to equipment from over or under tightening
- Proper connectorization at "F" connector interface with factory preset torque setting
- Audible "clicking" sound to indicate proper calibrated torque
- High visibility yellow cushion grip body
- Model number, torque inch-pounds and wrench size stamped on tool for easy identification
- Available in multiple torque (inch-pound) settings and wrench sizes (see models below)
- Wrenches work in tightening mode only
- Length: 6.50 in (165 mm) • Weight: 6.5 oz (182 g)

# TW

- Available in a range of **straight head** sizes
- **Tap port re-threader** on end of tool body
- Handy, removable belt loop



Torque in inch-pounds	Torque in Newton Meters	Wrench Sizes & TW Model Numbers			
		*7/16 inch (11.1 mm)	1/2 inch (12.7 mm)	9/16 inch (14.3 mm)	5/8 inch (15.9 mm)
20	2.26	TW 207	TW 208	-	-
25	2.82	TW 257	-	-	-
30	3.39	TW 307	TW 308	TW 309	TW 3010
40	4.51	TW 407	TW 408	TW 409	TW 4010

\* 7/16 in for universal "F" connectors

## TW-AH-B

- Basic **Angled head** model



Torque in inch-pounds	Torque in Newton Meters	Wrench Size Model Number
20	2.26	All wrenches 7/16 inch (11.1 mm)
25	2.82	TW 207-AH-B
30	3.39	TW 257-AH-B
40	4.51	TW 307-AH-B
		TW 407-AH-B

## TW-AH-S

- **"Speed"** head allows fast tightening without removing wrench from connector



Torque in inch-pounds	Torque in Newton Meters	Wrench Size Model Number
20	2.26	All wrenches 7/16 inch (11.1 mm)
25	2.82	TW 207-AH-S
30	3.39	TW 257-AH-S
		TW 307-AH-S

## TW-AH-516

- **Angled head** for easy access
- **5/16"** socket on the end of tool body for tightening of tap faceplates



Torque in inch-pounds	Torque in Newton Meters	Wrench Size Model Number
20	2.26	All wrenches 7/16 inch (11.1 mm)
25	2.82	TW 207-AH-516
30	3.39	TW 257-AH-516
40	4.51	TW 307-AH-516
		TW 407-AH-516

## TW-AH

- **Angled head** for easy access
- **Tap port rethreader** on end of tool body
- Handy, removable belt loop



Torque in inch-pounds	Torque in Newton Meters	Wrench Size Model Number
20	2.26	All wrenches 7/16 inch (11.1 mm)
25	2.82	TW 207-AH
30	3.39	TW 257-AH
40	4.51	TW 307-AH
		TW 407-AH

## TW-AH/IT

- **Angle head** design
- **Connector insertion tool** on body for fast and easy "F" connector insertions
- Handy removable belt loop



Torque in inch-pounds	Torque in Newton Meters	Wrench Size Model Number
20	2.26	All wrenches 7/16 inch (11.1 mm)
25	2.82	TW 207-AH/IT
30	3.39	TW 257-AH/IT
40	4.51	TW 307-AH/IT
		TW 407-AH/IT

# S-200

## Security Shield Tool

- For use with 7/16 inch hex shielded "F" connectors
- New design with extended 7/16 inch shank allows the tools to be used with the TW Torque Wrenches in security shield applications
- Machined and heat treated steel for maximum durability
- Knurled handle allows for easy and secure gripping
- Steel loop permits additional tool turning leverage and serves as a convenient carrying loop for attachment to belt or pouch
- Length: 2.75 in (70 mm)
- Weight: 2.0 oz (57 g)



# IT-F59, 6, 11

**NEW**  
for 2006

## "F" Connector Insertion and Flaring Tool Combo

- For insertion of 59, 6, 7, & 11 series "F" connectors
- Makes "F" connector insertion fast and easy even in cold temperatures
- Flaring end of tool allows flaring or expansion of the cable providing easier insertion of "F" connectors
- Recommended for polyethylene jacketed cables and plenum cables
- Especially useful when using tri-shield and quad-shield cables
- Insures proper connector and cable interface
- Large plastic screwdriver-type handle provides leverage when inserting "F" connector to the drop cable
- Heat treated shank
- Length: 5.00 in (127 mm)
- Weight: 3.5 oz (99 g)



Model	Description
IT-F59, 6, 11-FT6	"F" Insertion and 6 Series Flaring Tool Combo
IT-F59, 6, 11-FT59	"F" Insertion and 59 Series Flaring Tool Combo
IT-F59, 6, 11-UE	"F" Insertion and Corning Gilbert 59/6 ULTRA-EASE™ "F" Insertion Combo (No Flaring Tool)

## TT 716

### Trap Tool

- Lightweight anodized aluminum and steel construction
- Fits all standard traps
- Fits 7/16" hex F-fittings
- 7/16" hex head is machined heat treated steel
- Length: 7.5 inches (19 mm)
- Weight: 2.5 oz (71 g)



## TST 716

### Trap Security Tool Combo

- Combines a trap wrench with a security wrench
- Fits all standard traps
- Lightweight anodized aluminum and steel construction
- Security wrench made of heat treated steel – fits 7/16" hex F-fittings
- Fits all sizes and types of metal security sleeves
- Length: 7.5 inches (19 mm)
- Weight: 2 oz (57 g)



## T-7916

### Tap Tool

- Has both 7/16" (11.1 mm) and 9/16" (14.3 mm) hex sizes
- Handy tool for tightening F connectors on tap ports where security shields are not used
- Works with most 59 and 6 hex connectors
- Works with most 59 & 6 compression "F" fittings (Arris-Digicon-S™&T™, Corning Gilbert ULTRAEASE™, PCT-DRS, PPC-EX & EX-XL, Thomas & Betts SNAP-N-SEAL®, Stirling-SPL)
- Works with some 7 & 11 compression "F" fittings (Corning Gilbert ULTRAEASE™-T, PPC-EX, Thomas & Betts SNAP-N-SEAL®, Stirling-SPL)
- Rugged, aluminum design
- Length: 5 inches (127 mm)
- Weight: 5 oz (142 g)

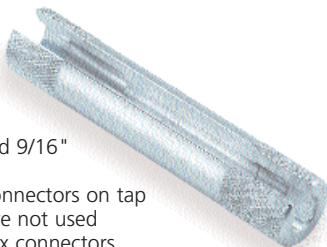

## CW-1

### Multi-Socket Can Wrench

**NEW**  
for 2006

- Wrench has reversible double sockets on each end
- Impact resistant polymer handle also provides a storage compartment for additional sockets
- **Wrench is supplied with hex sockets 7/16", 3/8", 5/16", 1/2", 1/4", and 5/32" Security Hex**
- Sockets are all clearly stamped with hex size
- Replaces the need to have 5 separate Nut Drivers
- Unique lightweight design that offers multiple tools in one handle
- Cost and application efficient
- Length: 7.75 in (197 mm)
- Weight: 10.4 oz (294 g)



## CW71638

### Can Wrench

**NEW**  
for 2006

- Allows universal access to network interface devices, telephone boxes and pedestals
- Tightens nuts on binding post terminals
- Deep 1 1/2" heat-treated sockets for long binding post
- Ribbed handle for comfort, safety and greater torquing capability
- Combines 7/16" and 3/8" thin wall sockets in one handle
- Wrench handle constructed of high quality impact and abrasion resistant polymer
- Handle has 7/16" and 3/8" markings at the socket ends to distinguish each socket size
- Length: 7.00 in (177.8 mm)
- Weight: 4.9 oz (139 g)



## TT8

### Tap Tool - Extra Long

**NEW**  
for 2006

- Extra long tap tool, 8" (203 mm) in length with 7/16" (11.1 mm) hex size
- Clear anodized aluminum construction
- Design has a 7/16 inch shank on opposite end of tool that allows the use of the Cablematic TW Torque Wrench series
- Length: 8 in (203mm)
- Weight: 3.2 oz (91 g)



## TT8-TW40

### Tap Tool with attached Swivel Torque Wrench

**NEW**  
for 2006

- Extra long 7/16" (11.1mm) Tap Tool with attached swivel 40 in/lb Torque Wrench attached
- Ideal for hard to reach locations where a preset torque setting is required on the "F" connector interface
- Tool has audible "clicking" sound to indicate when the connector is torqued to the proper factory set wrench setting
- Other torque settings are available upon request
- Rugged steel and aluminum construction
- Length: Tap Tool section – 8.00 in (203mm) Torque Wrench section – 6.50 in (165mm)
- Weight: 9.6 oz (272 g)



## DK 1

### Drop Cable Preparation Kit

- Complete 59 and 6 Series drop cable preparation kit in one convenient lightweight case
- Ideal for the electrical contractor installing CATV in residential homes
- Kit includes: 1 CR 360 Crimp Tool with .360 inch (9.1 mm) hex size, 1 SDT-596-250 Drop Trimmer, 0.25 inch (6.35 mm) preparation, IT 59, 6, 11 Connector Insertion Tool, Pack of 59 & 6 series Universal "F" connectors (15 ea)
- Tool kit dimensions: 13.50 x 10.25 x 3.25 in (343 x 260 x 83 mm)
- Weight: 3 lbs 14 oz (1.77 Kg)



## RPT

### Premise Toner Drop Cable Continuity Tester

- LED indicates DC shorts, splitters, and other self-grounding devices in cable
- Loud audio tone identifies line carrying signal
- Checks circuit integrity in new and/or installed cable
- Right angle male push-on connector lets you work in tight areas
- Female push-on connector for speed toning
- Tests up to 5,000 ft (1500 m) of cable
- Clips to shirt pocket for easy accessibility
- Battery included (12 volt)
- Replacement Toner Section: 35916
- Replacement RPT Battery 12 volt: 35917
- Length: 4.25 in (108 mm) • Weight: 2 oz (57 g)



## LTT-4, LTT-7

### Locking Terminator Tools

- Used on the following locking terminators:  
Corning Gilbert — GTP  
PCT International — TPG  
PDI Incorporated — PTP-59, PTP-59LR, PTP-59-PB  
PPC — LFT & PST  
Signal Vision, Inc. — SV-LT & SV-LTA  
Viewsonics — TR 75 GTL
- Available in two convenient lengths (as shown below)
- Longer and larger handle diameter on LTT-7 (1-1/4 inch / 31.8 mm diameter) for better grip and leverage
- Smaller diameter handle on LTT-4 (1 inch / 25.4 mm diameter) provides easier access between trap shields on tap spigots
- Tip design keeps out foreign debris, which could interfere with proper tool operation



Model	Length		Weight	
	(inch)	(mm)	(oz.)	(gram)
LTT-4	4-1/2	114	1.9	54
LTT-7	8	203	4.2	118

# LTT-7/V23, LTT-7/T-P, LTT-7/NS6270

**LTT-7/NS6270  
NEW for 2006**

## Locking Terminator Tools

- Two terminating tools integrated into one versatile tool
- One tool that can now handle a majority of the popular terminators found in the field
- Combo tool takes up less space in the installers tool pouch
- Model LTT-7/V23 has the Viewsonics (2 and 3 prong) terminating tool on the opposite end of the LTT tool
- Model LTT-7/T-P has the PPC-502 and the T&B -CLF/TRLF terminating tool on the opposite end of the LTT tool
- Model LTT-7/NS6270 has the Corning Gilbert NS-5762 Series termination tool on the opposite end of the LTT tool
- LTT-7/V23 Length: 8.25" (210 mm) • Weight: 4.34 oz (123 g)
- LTT-7/T-P Length: 7.875" (200 mm) • Weight: 4.34 oz (123 g)
- LTT-7/NS6270 Length: 8.25" (210mm) • Weight: 4.34 oz (123 g)

## Ordering Guide

Model	Terminator						
	Corning Gilbert	PPC	PCT Int'l	Viewsonics	Signal Vision	PDI, Inc	T&B
LTT-7/V23	GTP	LFT PST	TPG	TR75GTL TRWGTL TR75GTL-PB TRWRLT* TR75LT* TR75LT-PB* TRWRLT3 TR75LT3 TR75LT3-PB	SV-LT SV-LTA	PTP-59 PTP-59LR PTP-59-PB	
LTT-7/T-P	GTP	LFT 502 LTR 502 LTR NR PST	TPG	TR75GTL TR75GTL-PB TRWGTL	SV-LT SV-LTA	PTP-59 PTP-59LR PTP-59-PB	CLF CLFA TRLF TRLFA
LTT-7/NS6270	GTP	LFT PST	TPG	TR75GTL TR75GTL-PB TRWGTL	SV-LT SV-LTA	PTP-59 PTP-59LR PTP-59-PB	

\* Viewsonics 2-prong terminators



## RT-F716

### Removal Tool

- Provides easy access to connectors in high-density locations such as cable racks
- 7/16" head for "F" Connectors
- Socket extends 8" from handle
- Length: 11.75 in (298 mm)
- Weight: 3.4 oz (88 g)



## RT-BNC

### Removal Tool

- Provides easy access to connectors in high-density locations such as cable racks
- Formed head specifically for BNC connectors
- Socket extends 8" from handle
- Length: 11.75 in (298 mm)
- Weight: 3.1 oz (88 g)



## THT-532

### 5/32" Telephone Hex Tool

- Used to open 5/32" hex tamper resistant fasteners on communication pedestals and boxes
- Heat-treated carbon steel shaft for long lasting strength
- Four inch long plastic handle for extra leverage
- Length: 10.00 in (254 mm)
- Weight: 3.6 oz (101 g)



## CTB

### Canvas Tool Bag



- Keeps tools ORGANIZED, CLEAN, DRY and in one location, ready when you need them
- Heavy duty No. 8 white canvas construction that stands up to field use
- Vinyl coated waterproof interior stays dry in wet environments
- Varied pocket sizes fit a wide range of tools (Coring tools, Cable Cutters, Wrenches, Pliers, Screwdrivers, etc.)
- Padded interior for extra tool protection
- Approximate Dimensions:  
21" long x 12" high x 6" deep (533 x 305 x 152 mm)
- Weight 2 lbs, 3 oz. (990 g)

## CT 375

### Carpet Cutter & Drill Guide

- For making fast and precise holes in carpeting
- CT-375 is for wood underfloors (scalloped edge cutter)
- CT-375C is for concrete and other underflooring (smooth cutter)
  - Replacement Blades:  
Scalloped Part Number - 33483  
Smooth Part Number - 33482
  - Length: 3.0 x 6.375 in  
(76 x 162 mm)
  - Weight: 15 oz (426 g)



## Cable Caddies

- Lightweight cable caddy line designed for the proper dispensing and handling of common size drop cable reels
- Unique, ergonomic procedure for loading reels reduces unsafe lifting practices by eliminating lifting reel onto caddy
- Sturdy, 1" tubular steel construction
- High visibility yellow color easily seen in and around trucks and work sites
- Base model (**CCD-1**) designed to offer a simple, economical solution for a single spool of drop cable
- Also available with an optional lifting handle that is detachable (**Model CCD-1H**)
- Maximum rated load: 200 lbs (91 Kg)



**CCD-1**



**CCD-1H**

## Collapsible Caddy

- **CCD-CL** cable caddy is designed to fold up when lifted – with or without the cable reel installed
- Allows for easy storage
- Maximum Rated Load: 200 lbs (91 Kg)



**CCD-CL**

## Collapsible Caddy with Wheels

- Rugged 6" (152 mm) wheels allow for ease of movement and stability
- Holds up to one 20" x 16" in reel
- Caddy folds for easy storage
- Sturdy, 1" tubular steel construction
- Maximum rated load: 200 lbs (91 Kg)



**CCD-CLW**

## Cable Caddy Models

Model	Caddy Dimensions L x W x H	Weight in Pounds	Max Spool Size Diameter x Width (inches)
CCD-1	22 x 22 x 16 in (559x559x406 mm)	5.5 lbs (2.5 Kg)	18 x 16 in (457 x 406 mm)
CCD-1H	22 x 22 x 24 in (559x559x610 mm)	7 lbs (3.2 Kg)	18 x 16 in (457 x 406 mm)
CCD-CL	30 x 22 x 23-1/2 in (762x559x597 mm)	6.6 lbs (3.0 Kg)	18 x 16 in (457 x 406 mm)
CCD-CLW	30 x 26 x 23-1/2 (762x660x597 mm)	15 lbs (7.0 Kg)	20 x 16 in (508 x 406 mm)

## DC-MSES

### Mid-Span Duct Cutter

- Tool is duct size specific and designed for fast, safe and precise cutting in all mid-span applications
- Clam shell design allows the user to open the tool up in two halves, attach around the duct and rotate around the duct to begin the cutting action
- Ideal for mid-span buried duct (conduit) applications where space around the duct is very limited and access to cables within the duct is necessary without nicking the cables
- Adjustable blade depths to accommodate different duct thicknesses
- Rugged anodized aluminum and steel construction
- Replacement blade: CB 257
- Length: 4.25 in (108 mm)
- Weight: 13 oz (372 g)



Model	Duct Size	Replacement Blades	Body Color
DC-MSES-34	3/4"	CB 257	Blue
DC-MSES-114	1-1/4"	CB 257	Red
DC-MSES-112	1-1/2"	CB 257	Gold
DC-MSES-2	2"	CB 258	Green

## DC 100

### Cable Duct Cutter

- For precision cutting of smooth or corrugated cable duct
- Portable, compact and lightweight
- Handles .75 to 2.50 inch (19.1 to 63.5 mm) diameter nonmetallic ducts with max. .3125 inch (7.94 mm) wall thickness
- Blade guide permits accurate depth of cut
- Cutting guide permits accurate cuts around and/or along duct
- Cordless operation; comes with two 9.6V batteries and either 12VDC or 115VAC battery charger
- U.S. Patent No.: 5,305,529
- Length: 13 in (330 mm)
- Weight: 3 lb 8 oz (1.59 Kg); 7 lb 10 oz (3.46 Kg) with batteries and charger

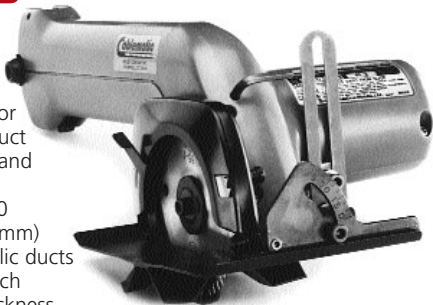

# Wireless Tools

## MSES-50

### Mid-Span/End Stripper

- Mid-span and end stripping tool for fast and efficient removal of cable jacket on wireless 50 ohm coaxial cable
- Designed to easily remove a section of cable jacket at mid span for the purpose of ground strap installation
- The tool is self-feeding and can easily strip any desired length
- Tools are cable size specific and designed to strip cable with no outer conductor damage
- Unique spring loaded locking bolt opens the tool body halves for quick and easy positioning onto the cable
- Convenient pull ring at the end of the locking bolt also serves as a means of attachment to tool belt / pouch
- Length: 4.3 in (109 mm) • Weight: 12.5 oz (354 g)

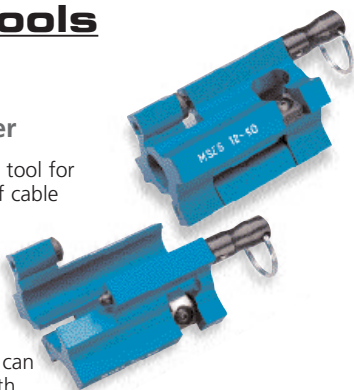

### Ordering Guide for MSES-50 Mid Span/ End Stripper (for wireless 50 ohm coaxial cable)

Andrew, Eupen, NK, and RFS Cables

Model Number	Cable Size (inch)	Replacement Blades	Body Color
MSES-214-50	2-1/4	CB 243	Silver
MSES-158-50	1-5/8	CB 217	Black
MSES-114-50	1-1/4	CB 217	Gold
MSES-78-50	7/8	CB 222	Copper
MSES-12-50	1/2	CB 223	Blue

Trilogy Cable (AirCell®)

Model Number	Cable Size (inch)	Replacement Blades	Body Color
MSES-MC <sup>2</sup> -50-1875J	1-5/8	CB 217	Gold
MSES-MC <sup>2</sup> -50-1000J	7/8	CB 222	Gold
MSES-MC <sup>2</sup> -50-750J	5/8	CB 223	Gold
MSES-MC <sup>2</sup> -50-500J	1/2	CB 223	Gold

CommScope® Cable (Cell Reach™)

Model Number	Cable Size (inch)	Replacement Blades	Body Color
MSES-CR-50-1873	1-5/8	CB 233	Gold
MSES-CR-50-1070	7/8	CB 234	Gold
MSES-CR-50-540	1/2	CB 235	Gold

Times Microwave Cable (LMR®)

Model Number	Cable Size (inch)	Replacement Blades	Body Color
MSES-GST-1700	1.7	CB 217	Copper
MSES-GST-1200	1.2	CB 222	Copper
MSES-GST-900	0.9	CB 223	Copper
MSES-GST-600	0.6	CB 223	Copper

## Wireless Tools

### FT-12-50, FT-78-50, FT-114-50, FT-158-50

Flaring Tools for 1/2", 7/8", 1-1/4" & 1-5/8"  
50 ohm Annular Corrugated Cable

- For flaring the outer conductor end on 50 ohm 1/2", 7/8", 1-1/4" and 1-5/8" Annular Flexible Foam Core Cable
- Fast, efficient and precise flaring
- Large plastic screwdriver-type handle provides exact leverage while rotating the tool
- For 1/2" cable, use model FT-12-50; For 7/8" cable, use model FT-78-50; For 1-1/4" cable, use model FT-114-50; For 1-5/8" cable use FT-158-50
- Made in U.S.A.
- Length: 5.00 in (127 mm)
- Weight: 3.50 oz (99 g)



## HSK

### Antenna Hole Saw Kits

- For the installation of permanent mount mobile antennas
- Depth of hole limited to .125 inch (3.18 mm) to prevent damage to underlying headliners of vehicles
- Special drill bit restricts walking of the saw
- Shoulder scores paint for improved grounding
- Designed for 3/8 inch (9.5 mm) or larger electric drills
- Length: 2.5 in (64 mm)
- Weight: 4.0 oz (113 g)



Model	Hole Sizes (Inch)	Hole Sizes (mm)
HSK-1	3/4 and 1-5/16	19.05 mm and 33.3 mm
HSK-19	3/4	19.05 mm
HSK-33	1-5/16	33.3 mm

Components	Description
HSA-1	Arbor
HSC-19	3/4 inch (19.05 mm) collar assembly
HSC-33	1-5/16 inch (33.3 mm) collar assembly
SB-89	3/4 inch (19.05 mm) two-blade pack
SB-88	1-5/16 inch (33.3 mm) two-blade pack
HSPD-1	3/16 inch (4.76 mm) pilot drill bit